

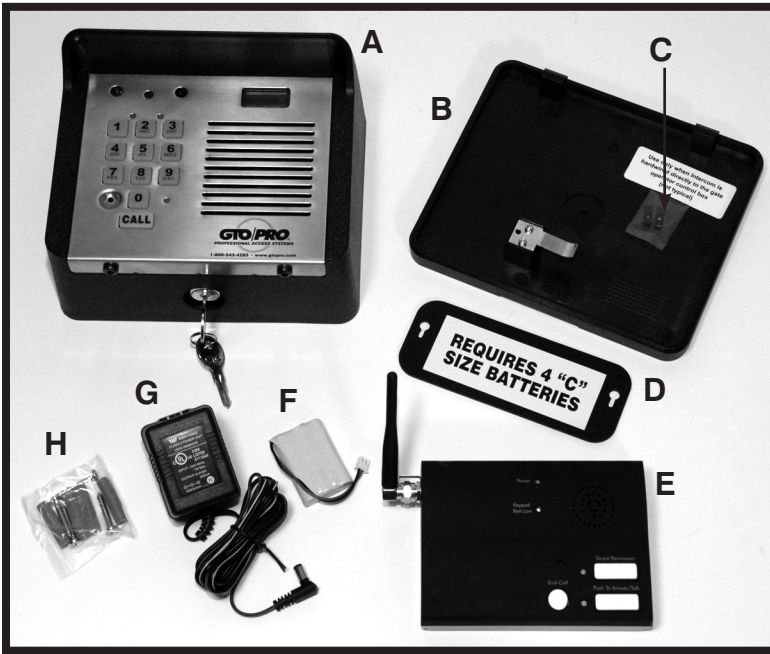

# Wireless Estate Intercom Installation Manual



## Kit Includes:

- A. Keypad
- B. Keypad Cover
- C. Jumper (required for hard-wired installation)
- D. Keypad Battery Cover
- E. Base Unit
- F. Base Unit Rechargeable Battery
- G. Transformer
- H. Screws for mounting Keypad Cover

## ⚠ WARNING

NEVER install the keypad portion of this system where a person can reach through the gate to activate it, or where a person can touch the gate while activating the keypad. The recommended minimum distance between the gate and keypad is 10 ft.

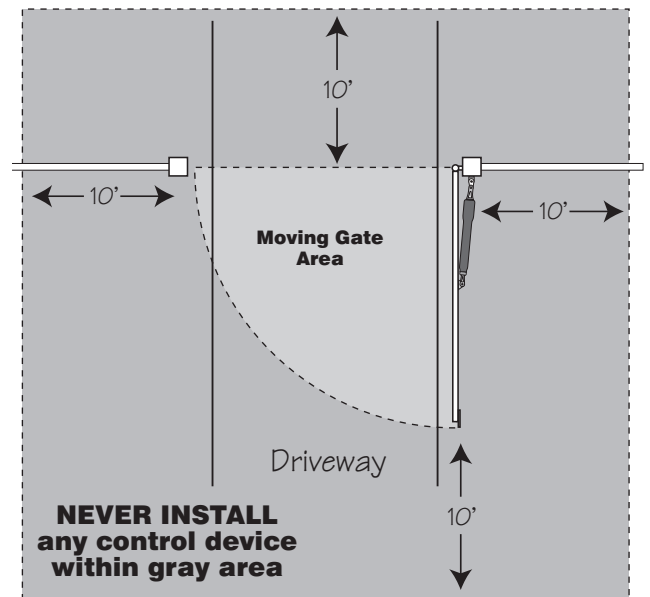

## How it Works:

A visitor without an entry code presses the CALL button on the keypad. The base (indoor) unit and the keypad will ring. A user at the base (indoor) unit answers the call by pressing the PUSH TO ANSWER/TALK button. The user at the base unit then presses the GRANT PERMISSION button to allow the visitor to operate the gate. The keypad's GRANTED light comes on, indicating that the visitor can now push any number key on the keypad to open the gate.

Visitors with access codes simply use their code to operate the gate. Temporary codes can be programmed to expire within a set number of days.

# Estate Intercom/Keypad Features

## Keypad

- The keypad illuminates and beeps at the press of any key. At night, the keypad will illuminate when the proximity sensors detect motion near the keypad face.
- When a valid code is entered, the STATUS light will blink rapidly, the keypad will beep three times, and the GRANTED light turns green.
- The keypad remains active for 40 seconds after entering a valid code: pressing any key on the keypad while the gate is in motion will stop the gate; pressing any key while the gate is stopped will cause the gate to reverse direction. After 40 seconds, the keypad will beep 3 three times and go into "idle" mode, and the GRANTED light will turn off.
- If more than 20 key presses are entered without matching an Entry Code, the STATUS light will flash rapidly, an error tone will sound for 1 second, and the keypad will go into "lock-down" mode for 40 seconds.
- If more than 10 seconds elapse between key presses, the keypad will beep 3 three times and go into "idle" mode.

## Master and Entry Codes

- Up to 100 Entry Codes may be programmed into the keypad.
- Temporary Entry Codes can be programmed to expire within one to seven (1–7) days.
- Entry Codes remain stored in memory even when the keypad batteries go dead.
- All Entry Codes are deleted by pressing the RESET button on the keypad; Master Code defaults to "1234."

## Base Unit

- The base unit is powered by a rechargeable battery (included); the charge is maintained by the transformer.
- The base unit can be disconnected from the transformer allowing it to be moved anywhere within range.
- Up to three additional base units can be added to the system.

**NOTE: The keypad, not the base station, initiates the call and operates the gate. The base station is for answering calls and granting "permission" for the gate to be opened.**

INTERCOM/KEYPAD SPECIFICATIONS	
Frequency	318 MHz from keypad to gate opener 900 MHz from keypad to base station
Memory – Keypad	Stores up to 100 four-digit entry codes
Power Consumption – Keypad	60 mA when relay is closed
Power Supply – Keypad	Four C batteries (plus 8-24 Vdc for hard-wired installations)
Power Supply – Base Unit	9 Vdc 300 mA transformer; 3.6V Ni-MH 800 mA rechargeable battery pack
Range from Keypad to Base Unit	500' wireless
Range from Reypad to Gate Opener	50' wireless 100' wired using 16 AWG wire
Relay Output – Keypad	Momentary, normally open dry contact closes for 2 seconds upon activation
Relay Output Rating – Keypad	12 or 24 Vdc 100 mA
Wiring – Keypad Power & Relay Output	16 AWG stranded low voltage direct burial wire

FCC WARNING: Changes or modifications to this unit not expressly approved by the party responsible for compliance could void the user's authority to operate the equipment.

NOTE: This equipment has been tested and found to comply with the limits for a Class B digital device, pursuant to Part 15 of the FCC Rules. These limits are designed to provide reasonable protection against harmful interference in a residential installation. This equipment generates, uses and can radiate radio frequency energy and, if not installed and used in accordance with the instructions, may cause harmful interference to radio communications.

However, there is no guarantee that interference will not occur in particular installations. If this equipment does cause harmful interference to radio or television reception, which can be determined by turning the equipment off and on, the user is encouraged to try to correct the interference by one or more of the following measures: • Reorient or replace the receiver antenna. • Increase the separation between the equipment and the receiver. • Connect the equipment into an outlet on a circuit different from that to which the receiver is connected. • Consult the dealer or an experienced radio/TV technician for help.

# Keypad and Base Unit Overview

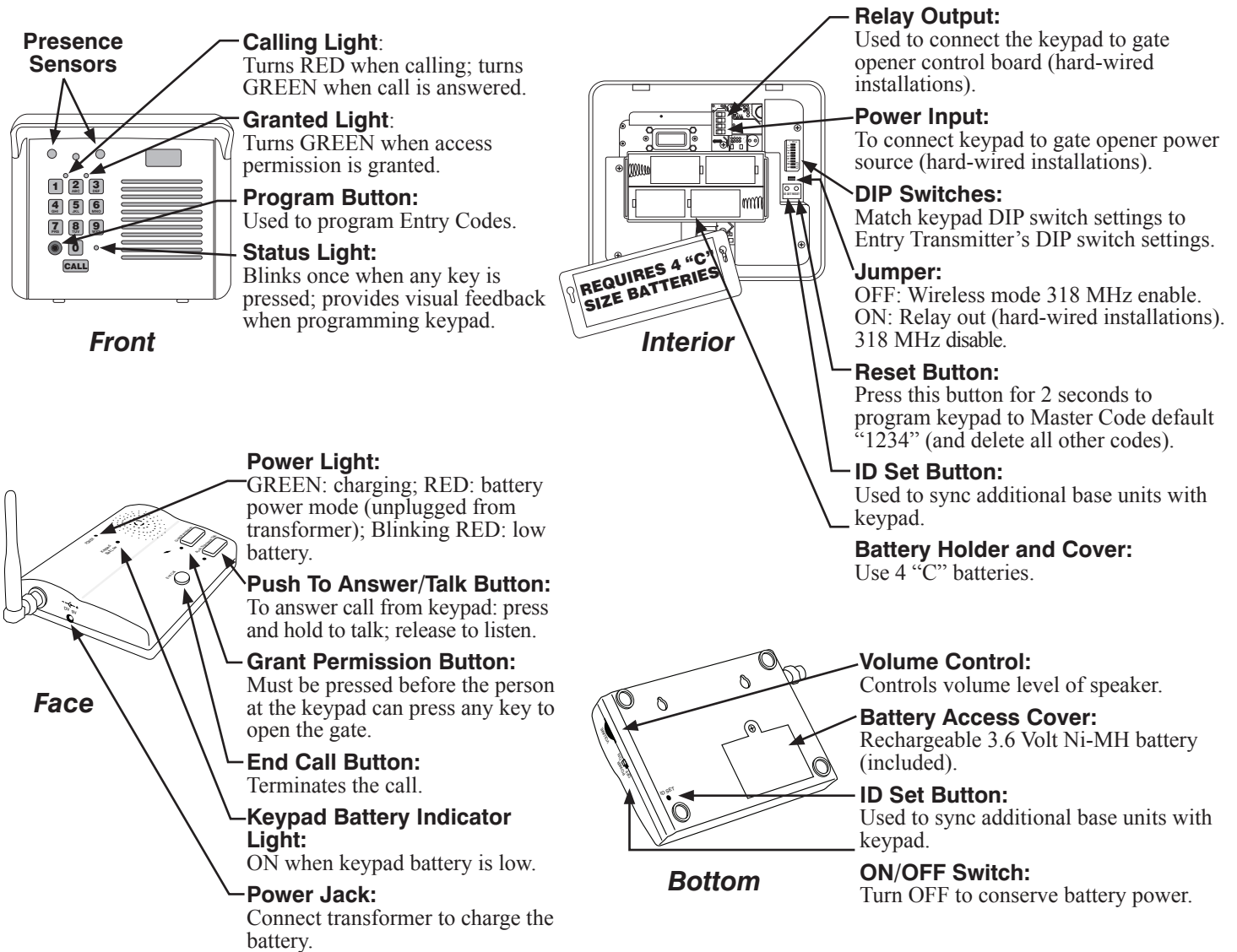

## 1. Install Keypad and Base Unit Batteries

**Step 1:** Unlock the bottom of the keypad and separate it from its cover. Remove battery cover and install four "C" batteries (required, not included). Replace the battery cover.

**Step 2:** Remove the base unit battery cover using a small phillips head screwdriver. Install the rechargeable Ni-MH battery (included). Replace battery cover.

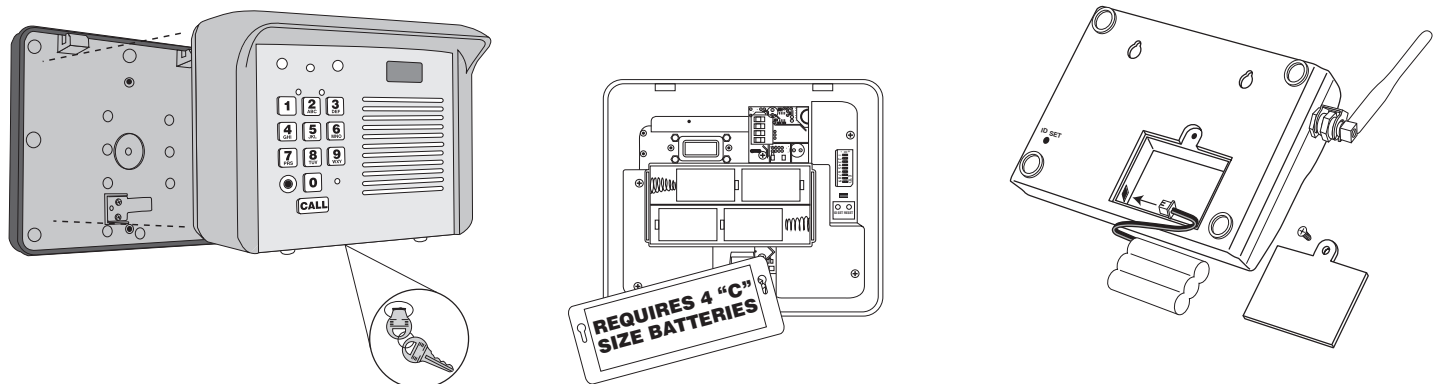

## 2. Connect the Transformer and Test Base Unit

**Step 1:** Find a convenient location near an AC outlet to mount or place the base unit.

**Step 2:** Plug the transformer into the outlet and connect it to the base unit.

The base unit can be disconnected from the transformer for use in another location. The battery will last approximately four (4) hours when unplugged from the transformer. **You can turn the base unit OFF to conserve battery power, however it will not receive a signal.**

**Step 3:** Test the base unit by pressing the CALL button on the keypad. The base unit will ring.

Charge battery for 12 hours before using the system for the first time.

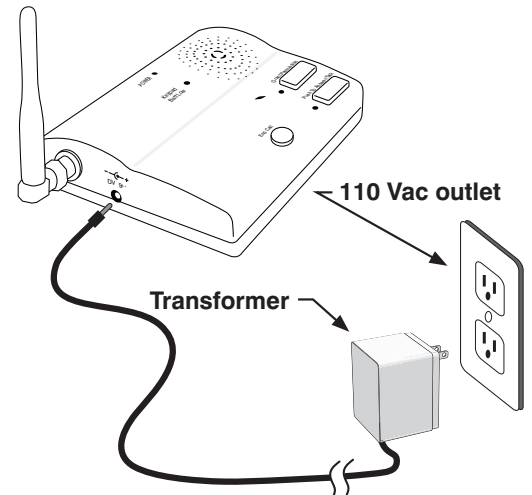

## 3. Install and Test Keypad

**You will need to hard-wire your keypad to the gate opener if you:**

- Do NOT have a GTO Entry Transmitter.
- Have a GTO Access Systems GP Series gate opener.
- Live in an area with high radio frequency interference.

**Skip to page 5 for instructions.**

For *wireless* applications, the keypad **must** be in line of sight of *and* no more than 50 ft. away from the gate opener receiver. Test the keypad range before permanently mounting it.

**Step 1:** At the gate, set the keypad DIP switches to match your Entry Transmitter's DIP switch settings. *NOTE: If you have not adjusted your gate opener's Entry Transmitter from the factory setting, see the "Personalize Transmitter Settings" section in your gate opener's installation manual.*

**Step 2:** Test the keypad using the default Master Code "1234." It will activate the gate.

**Step 3:** Test the keypad range by pressing the CALL button. You will hear the base unit ringing through the keypad speaker.

**Step 4:** Mount the keypad cover using the screws provided. *NOTE: a metal housing or metal object can affect range.*

**Step 5:** Slide the keypad into the cover and lock it.

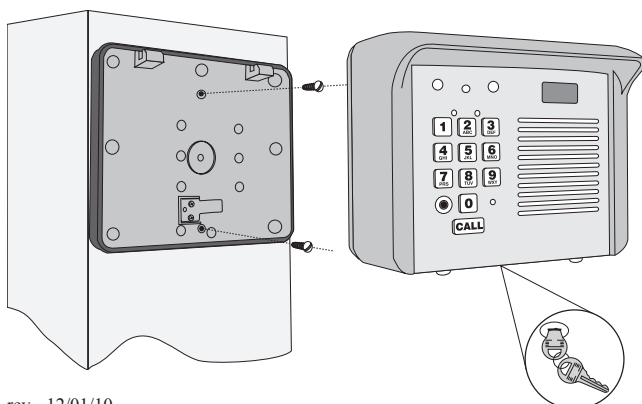

rev - 12/01/10

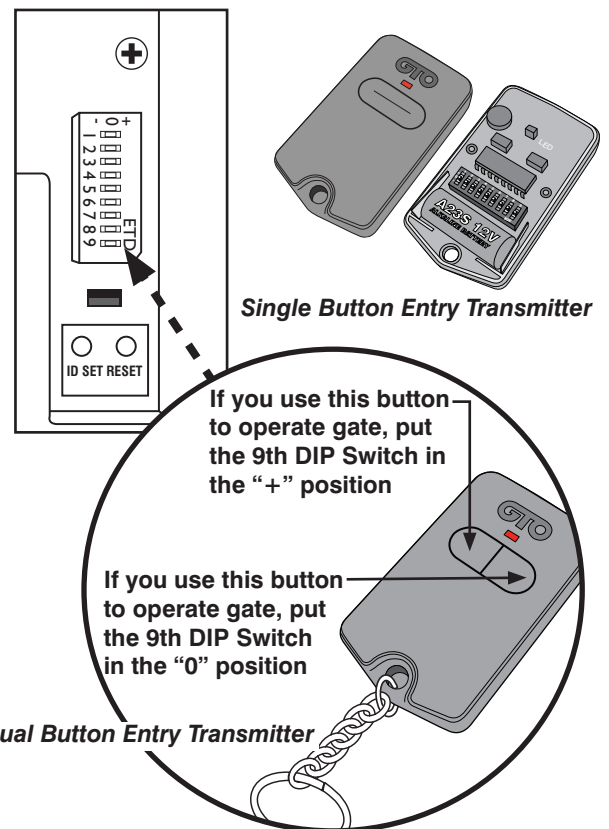

**Change the Keypad's DIP Switch Settings NOT the Entry Transmitter Dip Switch Settings**

## 4. Program the Keypad

- A Master Code is needed to add, remove, or program Entry Codes.
- Factory default Master Code is "1234."
- Keypad can only enter "program" mode from "idle" mode.
- Keypad will beep three times before going into "idle" mode (more than 10 seconds between key presses).



Program Button      Status Light

 **Programming Confirmed:** Keypad will beep 3 times.

---

 **Error Message:** Status light will flash rapidly, error tone will sound for 1 second and keypad will return to "idle" mode (changes not saved).

- Entry Code is not 4 digits.
- New Master Codes don't match ("Program New Master Code").
- Memory is full (already 100 codes).
- No matching code is found ("Delete Entry Code").

= Your 4-digit code.

### Program New Master Code

1. Press and Release Program Button: ●
2. Enter current Master Code:     Master Code  
(example: the factory default Master Code)      1    2 (ABC)    3 (DEF)    4 (GHI)
3. Press and Release Program Button: ●
4. Enter the Function Code:   Function Code  
0    6 (MNO)
5. Press and Release Program Button: ●
6. Enter the *new* Master Code:
7. Press and Release Program Button: ●
8. Enter the *new* Master Code again:
9. Press and Release Program Button: ●

### Add New Entry Code

1. ●
2.     Master Code
3. ●
4.   Function Code  
0    2 (ABC)
5. ●
6.     New Entry Code
7. ●

### Delete Entry Code

1. ●
2.     Master Code
3. ●
4.   Function Code  
0    3 (DEF)
5. ●
6.     Code to be deleted
7. ●

### Add Temporary Entry Code

\*In step 4, you will need to enter a number from 1 through 7 to indicate the number of days until the Entry Code expires.

1. ●
2.     Master Code
3. ●
4.   Function Code & # of days Code will be active\*  
8 (TUV)    1
5. ●
6.     Temporary Entry Code
7. ●

### Delete All Entry Codes

1. ●
2.     Master Code
3. ●
4.   Function Code  
0    7 (PRS)
5. ●



## Intercom ID Codes

This keypad and base unit are synced at the factory to communicate with each other. This base unit is considered to be “unit #1” when adding more base units to the system.

## 5. Sync Additional Base Units (optional)

If you purchased additional base units (F3101MBC), you must sync each additional unit with the keypad so they can communicate.

**Step 1:** Install the battery and turn the base unit ON.

**Step 2:** Press and release the “ID SET” button on the keypad.

**Step 3:** Press the number on the keypad that corresponds to the base unit you are adding. You will hear a number of beeps corresponding to the number you pressed. For example, if you are adding a second base unit to the system, press “2,” the keypad will beep TWO times. If you are adding a third base unit, press “3,” the keypad will beep THREE times, etc.

**Step 4:** Press the “ID SET” button on the base unit for approximately two seconds then release. You will hear THREE beeps from the base unit and THREE beeps from the keypad, which means the base unit and keypad are synced.

**IMPORTANT:** Base units need to be placed at least 10 feet apart to prevent interference.

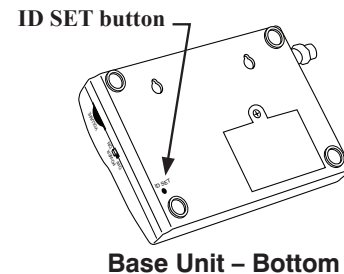
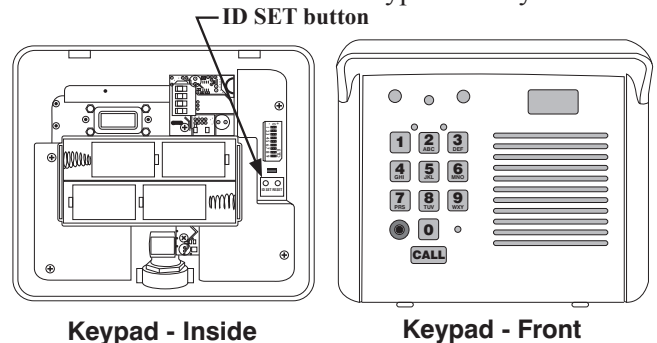

## 6. Test the Intercom

**IMPORTANT:** The base unit and the keypad cannot be within 15 feet of each other when operating. If units are closer than 15 feet, the signal will be inconsistent and emit feedback.

Have someone press the CALL button on the keypad. When the base unit inside the house rings, press the ANSWER button and talk to the person at the gate to check the connection and range. Then press the GRANT PERMISSION button and have the person press any key on the keypad to activate the gate.

## Using the Wireless Estate Intercom

*NOTE: The keypad, not the base station, initiates the call and operates the gate. The base station is for answering calls and granting “permission” for the gate to be opened.*

### Using the Intercom

- Press the CALL button on the keypad to ring the base unit inside the house.
- The base unit will ring when it receives a CALL from the keypad: hold the ANSWER button to talk to the visitor, release the ANSWER button to listen. Press the GRANT PERMISSION button to allow the visitor to open the gate (by pressing any number key on the keypad). The END CALL button terminates the call.
- After the keypad’s GRANTED light turns green, press any number key to open the gate.

### Using Entry Codes

- When a valid code is entered, the STATUS light will blink rapidly, and the keypad will beep 3 times.
- The keypad remains active for 40 seconds after entering a valid code: pressing any key on the keypad while the gate is in motion will stop the gate; pressing any key while the gate is stopped will cause the gate to reverse direction. After 40 seconds, the keypad will beep 3 three times and go into “idle” mode.
- If more than 20 key presses are entered without matching any Entry Codes, the STATUS light will flash rapidly, the error tone will sound for 1 second, and the keypad will go into “lock-down” mode for 40 seconds.
- If more than 10 seconds elapse between key presses, the keypad will beep 3 three times and go into “idle” mode.

# HARD-WIRED INSTALLATION

You will need two pairs of 16 gauge (AWG) stranded, direct burial, low voltage wire (**RB509**), one pair to hard-wire the communication between the keypad and the gate opener, the other to extend the life of the four “C” batteries. NOTE: The four “C” batteries are required for reliable operation of the keypad.

**Step 1:** Turn the gate opener’s power switch OFF.

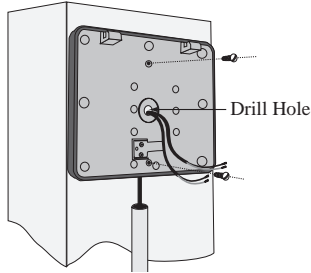

**Step 2:** Determine how the wires will enter the keypad (e.g., from the back through a hole drilled in the post; running the wire on the post surface). Drill a hole in the back of the keypad cover and pull the wire into the cover. Then mount the cover to the post using the screws provided. Run wire through PVC pipe from the ground to keypad and from the ground to the opener control board to protect it from lawn mowers or grazing animals.

**Step 3:** Wire the keypad to the gate opener control board. Strip 3/16” off the ends of one pair of low voltage wires. Attach the wires to the terminal block marked RELAY on the keypad control board as shown. Then connect wire #1 to the CYCLE terminal on the gate opener control board, and wire #2 to the COM terminal on the gate opener control board

NOTE: If you have a **PRO 1000/2000/SL1000/SL2000 gate opener**, connect wire #1 to the WHT accessory terminal, and wire #2 to the GRN accessory terminal.

Refer to your gate opener instruction manual for more details on wiring the gate opener control board.

**Step 4:** Wire the keypad to the battery. Strip 3/16” off the ends of the second pair of low voltage wires. Attach the wires to the terminal block marked POWER on the keypad control board as shown. Connect the other end of the wires to the opener’s battery: one end to the POSITIVE (RED) terminal and the other to the NEGATIVE (BLACK) terminal.

**Step 5:** Connect the jumper between the two terminals on the keypad control board (ON) as shown.

**Step 6:** Slide the keypad into the cover and lock.

**Step 7:** Replace the gate opener control board cover and turn the power switch ON.

**Step 8:** Program the keypad (page 3).

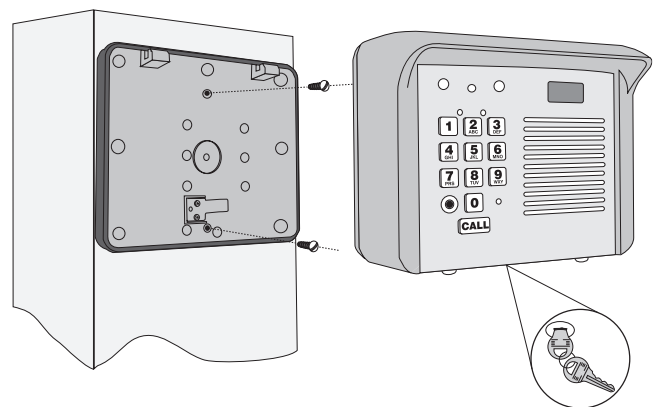
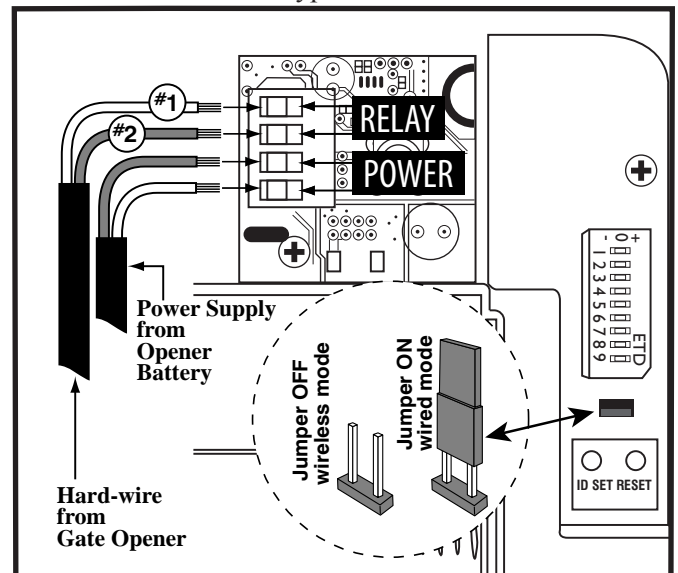

# Troubleshooting

## Pressing the keypad CALL button does not ring the base unit:

1. Check the batteries in the keypad and replace them if necessary.
2. Make sure the base unit is turned on and the volume is turned up.
3. Try moving the keypad and the base unit closer to each other (no closer than 15 ft.).
4. Perform “Sync” procedure below (this will require two people):
  - a. Open the keypad and locate the “ID SET” button above the batteries. Locate the “ID SET” button on the bottom of the base unit.
  - b. Make sure the “antenna-to-antenna” distance between the keypad and the base unit is at least 15 feet.
  - c. Press the “ID SET” button on the keypad until you hear a beep, then release.
  - d. Press the “ID SET” button on the base unit for approximately 2 seconds then release. You will hear ONE beep from the base unit and TWO from the keypad, which means the keypad and base unit are synced.
  - e. Test the system by pressing the CALL button on the keypad to see if the base unit receives the signal. Once the system is working, you will need to sync additional base stations (see page 4).

## The Master Entry Code does not open the gate and the GRANTED light does not turn green.

1. Check the batteries in the keypad and replace them if necessary.
2. Program the keypad (page 3).

## The Master Entry Code does not open the gate and the GRANTED light turns green.

### WIRELESS Installation:

1. Verify that your Entry Transmitter operates the gate.
2. Verify that the Keypad DIP switches are matched to the Entry Transmitter DIP Switches (page 2).
3. Make sure the JUMPER in the keypad is NOT installed (page 5).

### WIRED Installation:

1. Be sure the wires are securely connected to the gate opener control board (page 5).
2. Make sure the JUMPER in the keypad is installed (page 5).

## You've forgotten the Master Entry Code:

*The following will remove all Entry Codes from the keypad and program the Master Code back to factory default.*

1. Press and hold the RESET button in the keypad for two seconds. Master Entry Code is now “1234.”
2. Program the keypad (page 3).

### Limited One Year Warranty

Gates That Open, LLC (“GTO”). gate opener accessories are warranted by the manufacturer against defects in workmanship for a period of one (1) year from the date of purchase, provided recommended installation procedures have been followed.

In the case of product failure due to defective material or manufacturer workmanship within the one (1) year warranty period, the accessory will be repaired or replaced (at the manufacturer’s option) at no charge to the customer, if returned freight prepaid to GTO - Gates That Open, LLC • 3121 Hartsfield Rd. • Tallahassee, FL 32303. **IMPORTANT: Call 850/575-4144 or fax 850/575-8950 for a Return Goods Authorization (RGA) number before returning goods to factory. Products received at the factory without an RGA will not be accepted.** Replacement or repaired parts are covered by this warranty for the remainder of the one (1) year warranty period or six (6) months, whichever is greater. GTO will pay the shipping charges (equal to United Parcel Service GROUND rate) for return to the owner of items repaired under warranty.

The manufacturer will not be responsible for any charges or damages incurred in the removal of the defective parts for repair, or for the reinstallation of those parts after repair. This warranty shall be considered void if damage to the product(s) was due to improper installation or use, connection to an improper power source, tampering, or if damage was caused by lightning, electrical power surge, wind, fire, flood, insects, or other natural agent.

After the one (1) year warranty period, GTO or one of its authorized service centers will make any necessary repairs for a nominal fee. Call GTO at 850/575-4144 for more information. This warranty gives you specific legal rights, and you may also have other rights which may vary from state to state. This warranty is in lieu of all other warranties, expressed or implied. NOTE: Verification of the warranty period requires copies of receipts or other proof of purchase. Please retain those records.